

SWIVEL PLUMBING FOR ALA SWIVEL

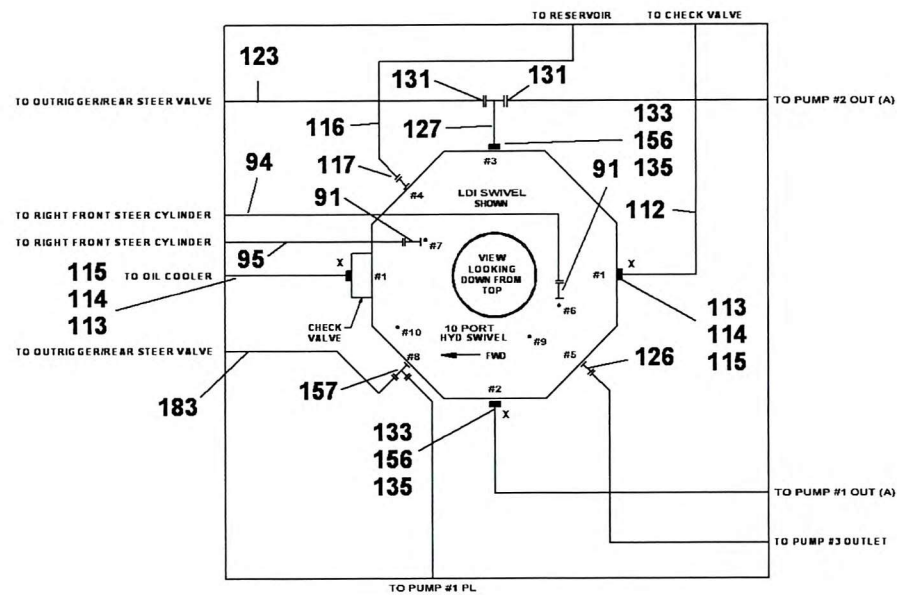

SWIVEL PLUMBING FOR LDI SWIVEL

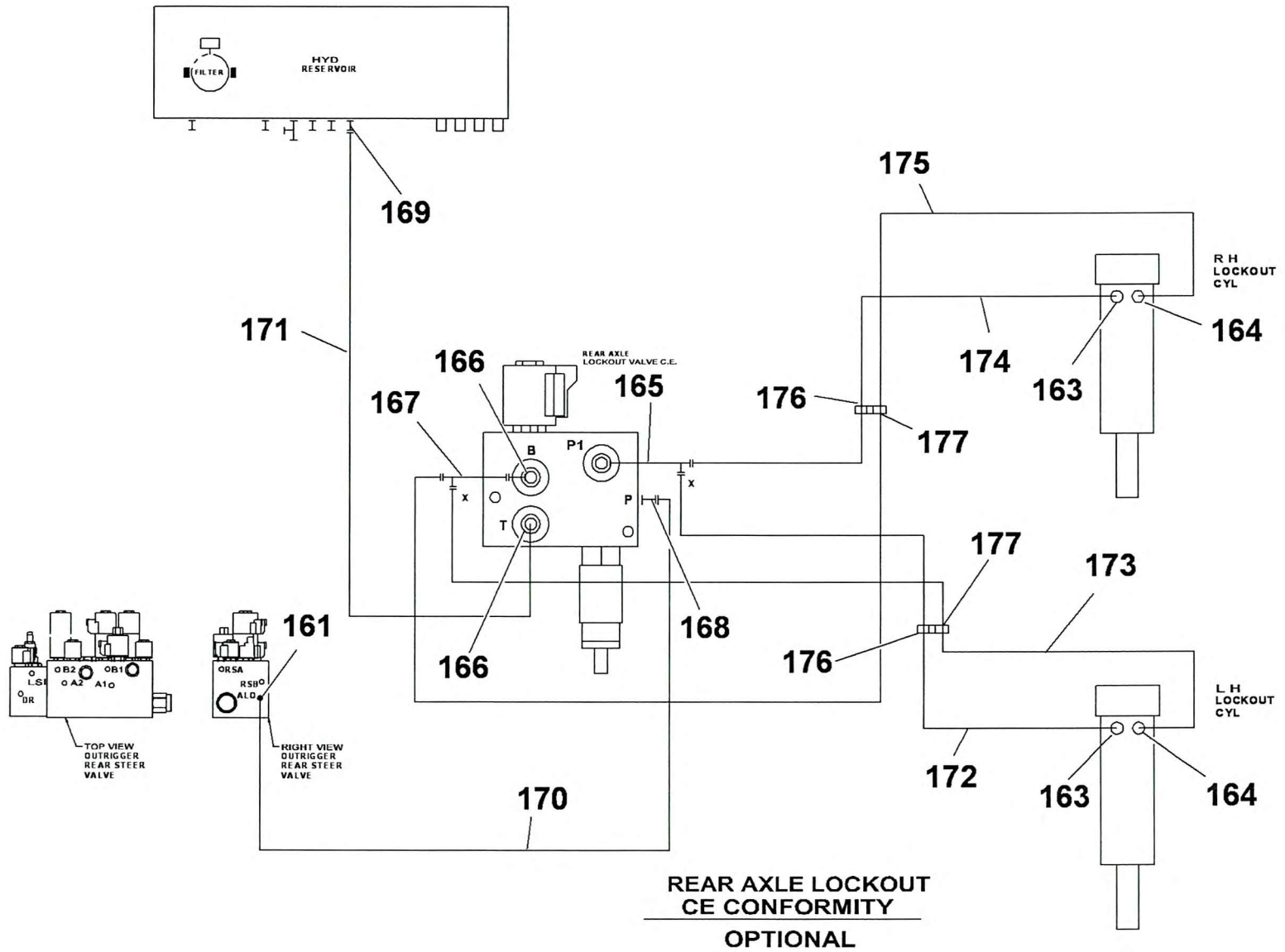

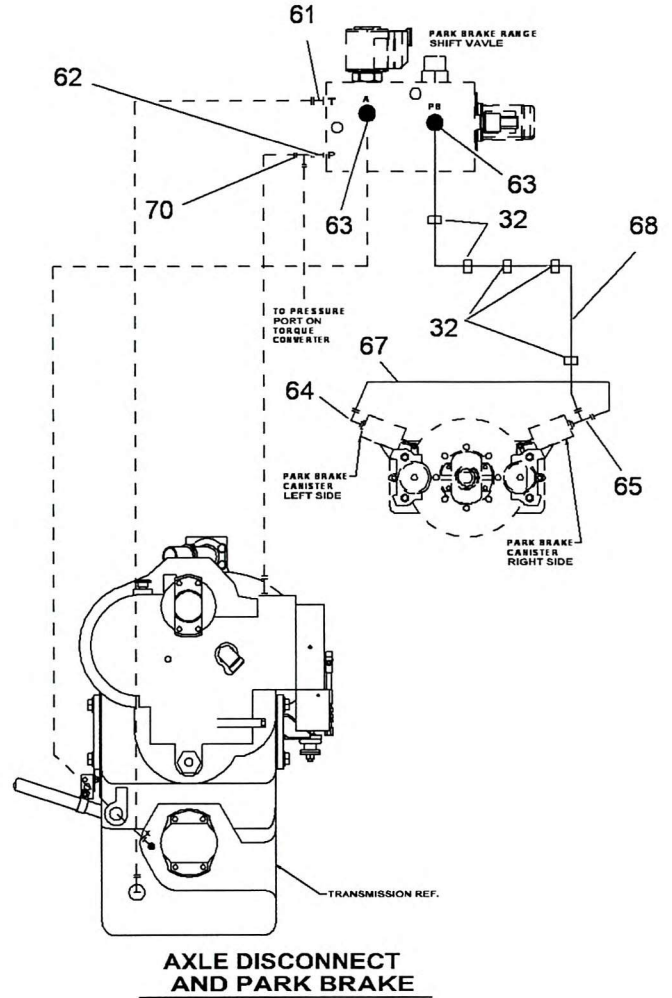
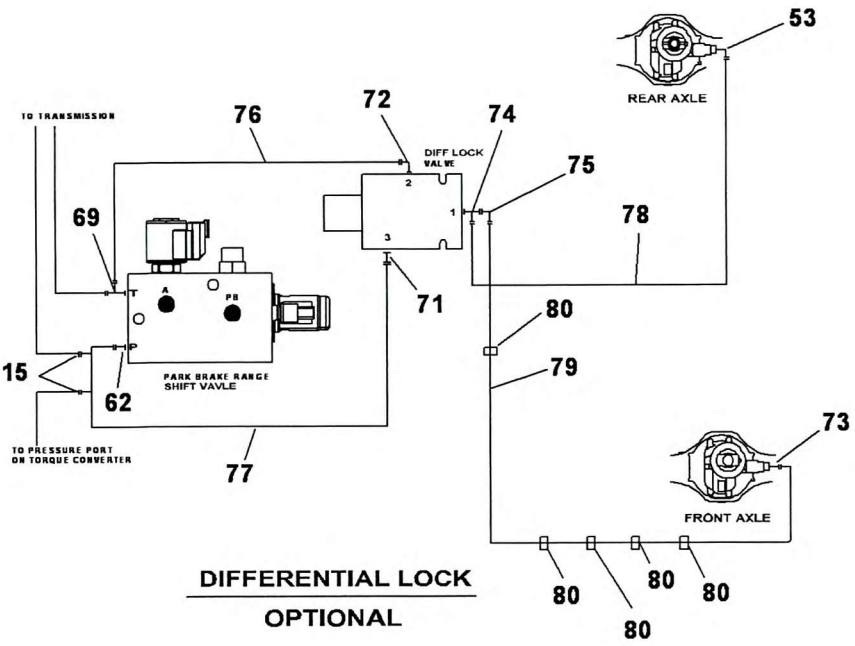

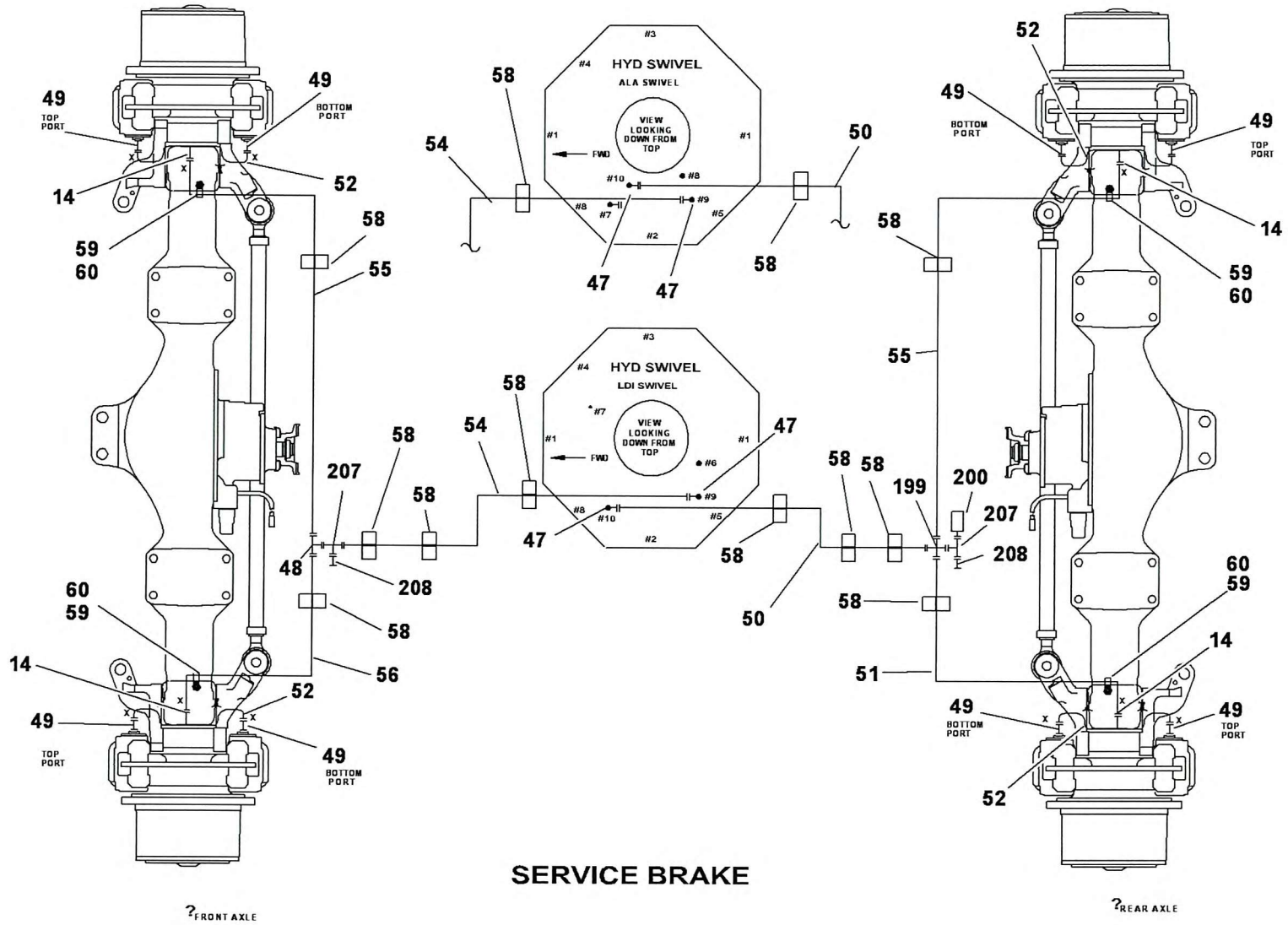

SERVICE BRAKE

FRONT AXLE

REAR AXLE

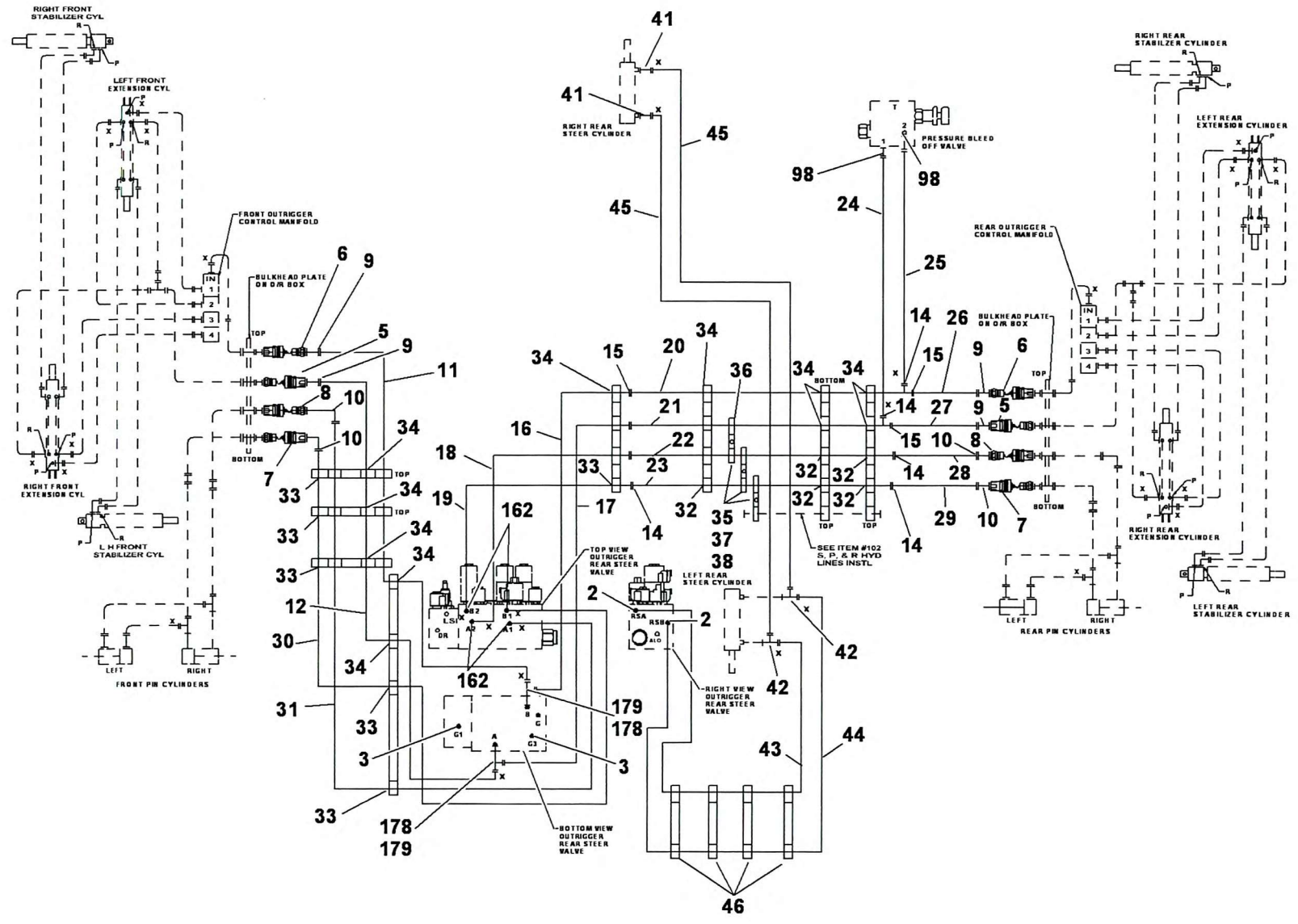

(SHEET 2 OF 6)

Page 701

80045278

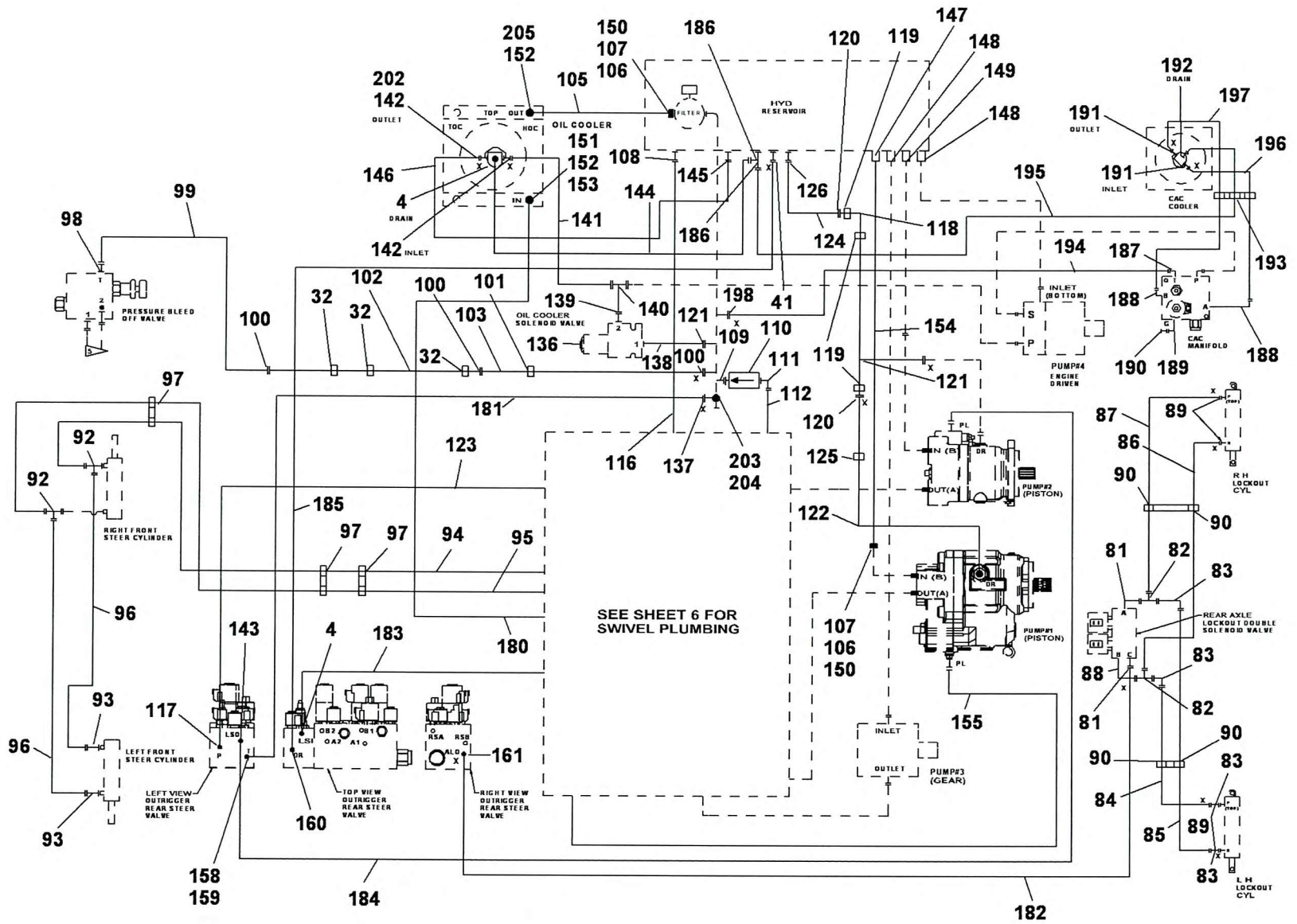

SUPPLY,PRESSURE & RETURN
FRONT STEER AND REAR AXLE L/O

80045278

(SHEET 1 OF 6)

Page 702